

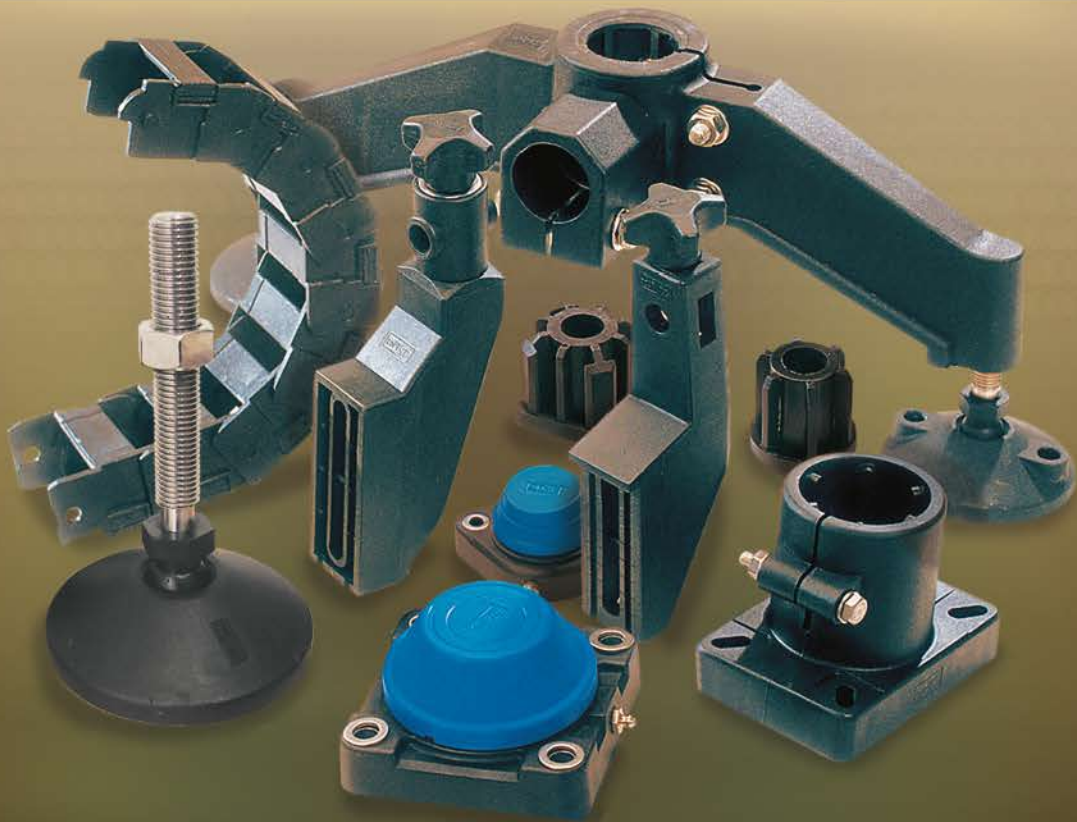

SurTécnica



COMPONENTES
COMPONENTS

S.B.E. - D.T.S.

S.B.E Modelo 1 Juego Completo Drip Tray Supports Mod. 1

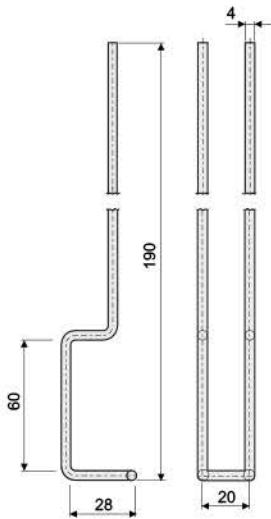

PIEZA	DESCRIPCIÓN	PESO
120	MODELO 1	88 g

VENTA	UNIDAD
COLOR	NEGRO Y ALUMINIO
MATERIALES	S.B.E./D.T.S.=AISI 304 PIEZAS/PIECES = PA INSERTOS/INSERTS = AISI 304

S.B.E Modelo 2 Juego Completo Drip Tray Supports Mod. 2

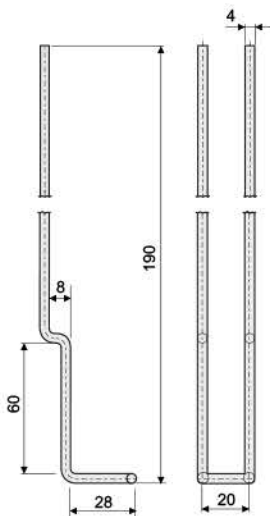

PIEZA	DESCRIPCIÓN	PESO
121	MODELO 2	65 g

VENTA	UNIDAD
COLOR	NEGRO Y ALUMINIO
MATERIALES	S.B.E./D.T.S.=AISI 304 PIEZAS/PIECES = PA INSERTOS/INSERTS = AISI 304

S.B.E. - D.T.S.

S.B.E Modelo 3-4 Juego Completo

Drip Tray Supports Mod. 3-4
Roler

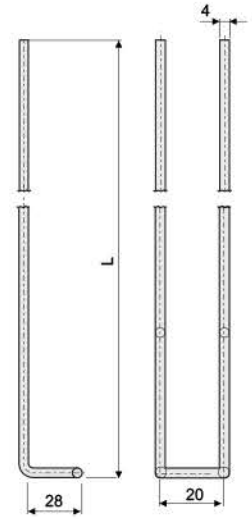

PIEZA	DESCRIP.	L	PESO
122	MODELO 3	190	74 g
123	MODELO 4	240	77 g



VENTA UNIDAD
COLOR NEGRO Y ALUMINIO

MATERIALES S.B.E./D.T.S. = AISI 304
PIEZAS/PIECES = PA
INSERTOS/INSERTS = AISI 304

S.B.E Modelo 5 Juego Completo

Drip Tray Supports Mod. 5

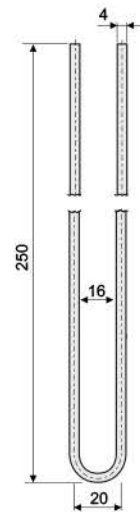

PIEZA	DESCRIPCIÓN	PESO
313	MODELO 5	75 g



VENTA UNIDAD
COLOR NEGRO Y ALUMINIO

MATERIALES S.B.E./D.T.S. = AISI 304
PIEZAS/PIECES = PA
INSERTOS/INSERTS = AISI 304

S.B.E. - D.T.S.

S.B.E Modelo 6 Juego Completo Drip Tray Supports Mod. 6

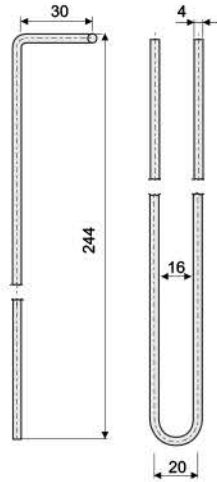

PIEZA	DESCRIPCIÓN	PESO
310	MODELO 6	75 g

VENTA	UNIDAD
COLOR	NEGRO Y ALUMINIO
MATERIALES	S.B.E./D.T.S.=AISI 304 PIEZAS/PIECES = PA INSERTOS/INSERTS = AISI 304

S.B.E Piezas Plásticas Plastic Pieces

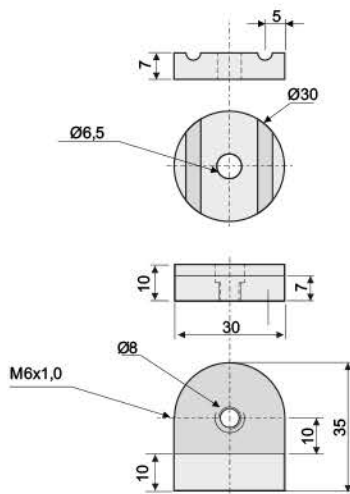

PIEZA	DESCRIPCIÓN	PESO
067	PIEZAS PLÁST. SOLAS (3)	28.8 g
961	PIEZA C/TUERCA INYECT. (1)	11 g
1451	CONJUNTO COMPLETO	50 g

VENTA	UNIDAD
COLOR	NEGRO
MATERIALES	S.B.E. ACCESORIOS/ D.T.S. ACCESORIES=PA TORNILLOS/SCREWS=AISI 304